

210

50 ft

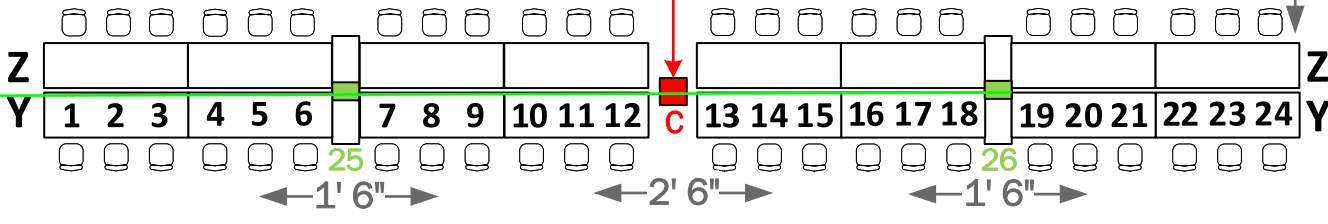

107

113

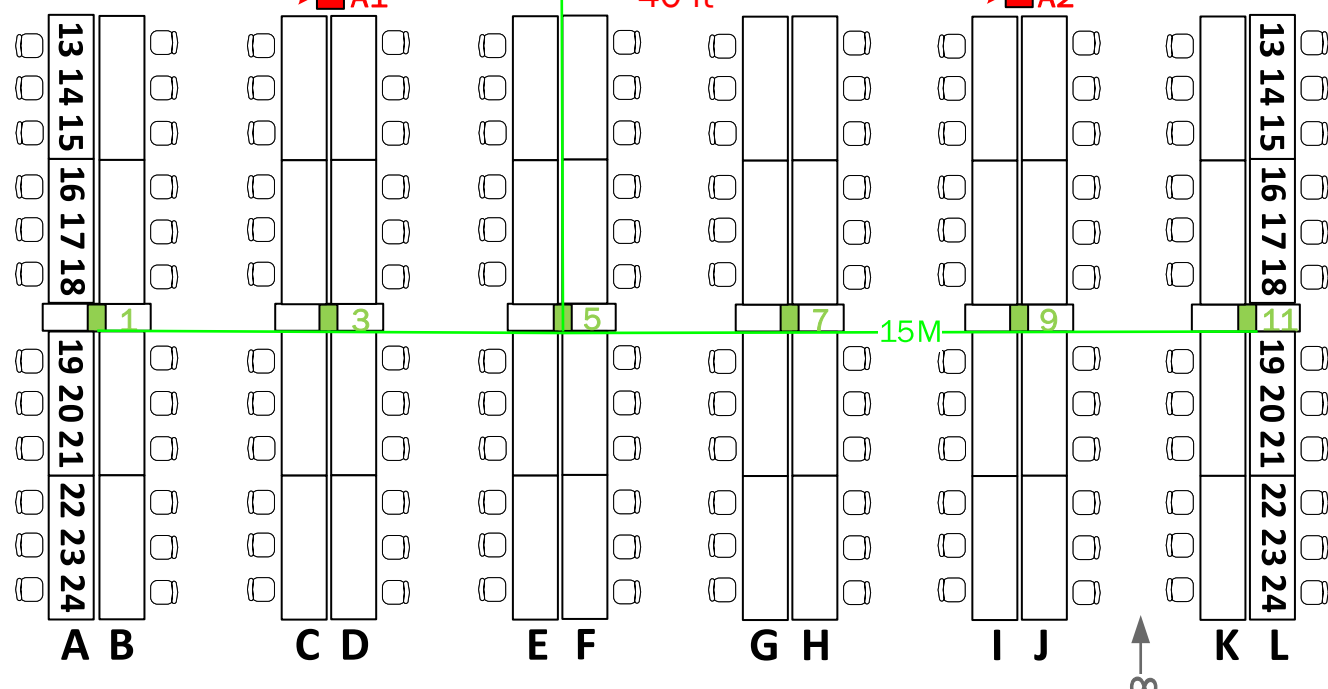
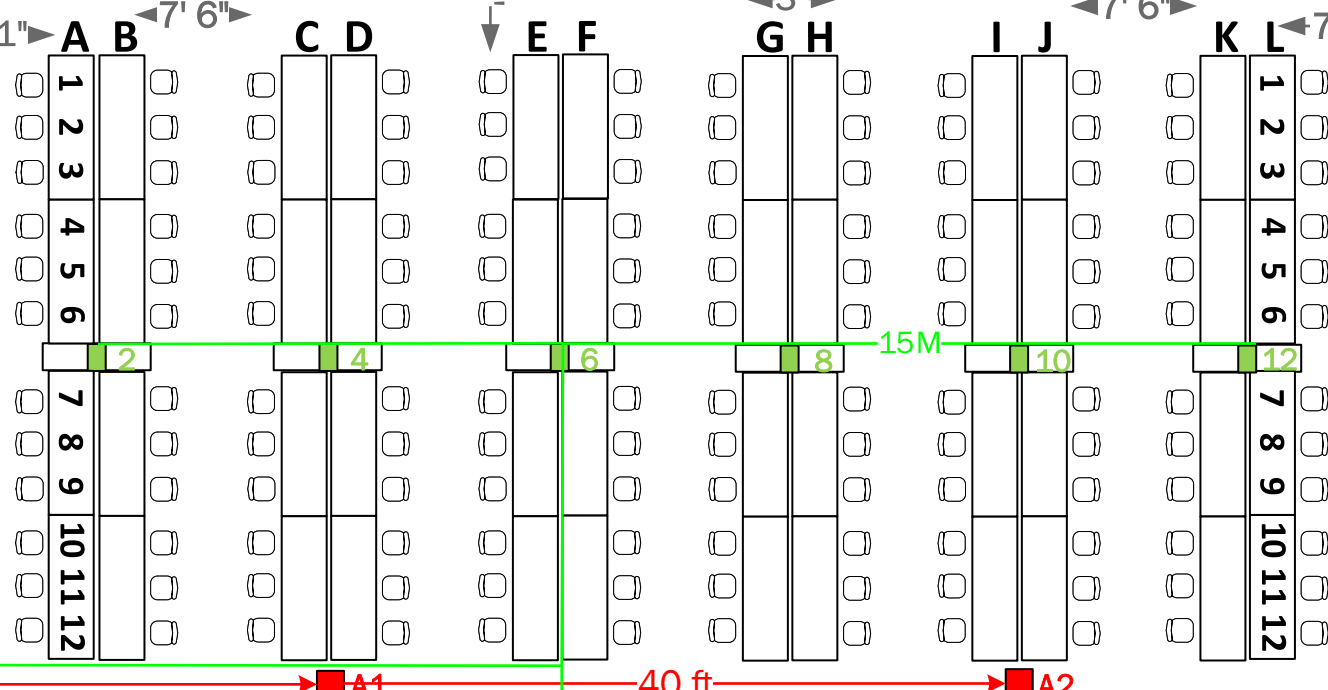
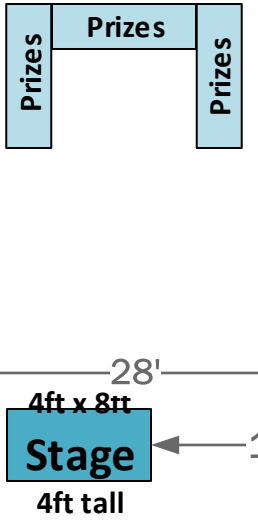
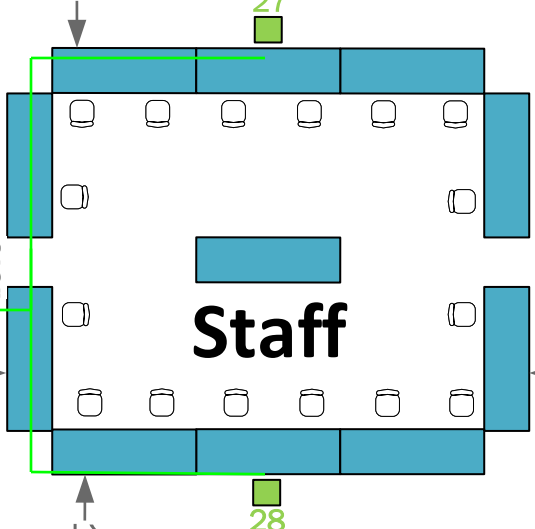
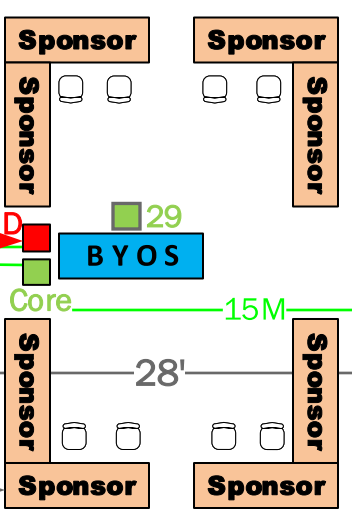
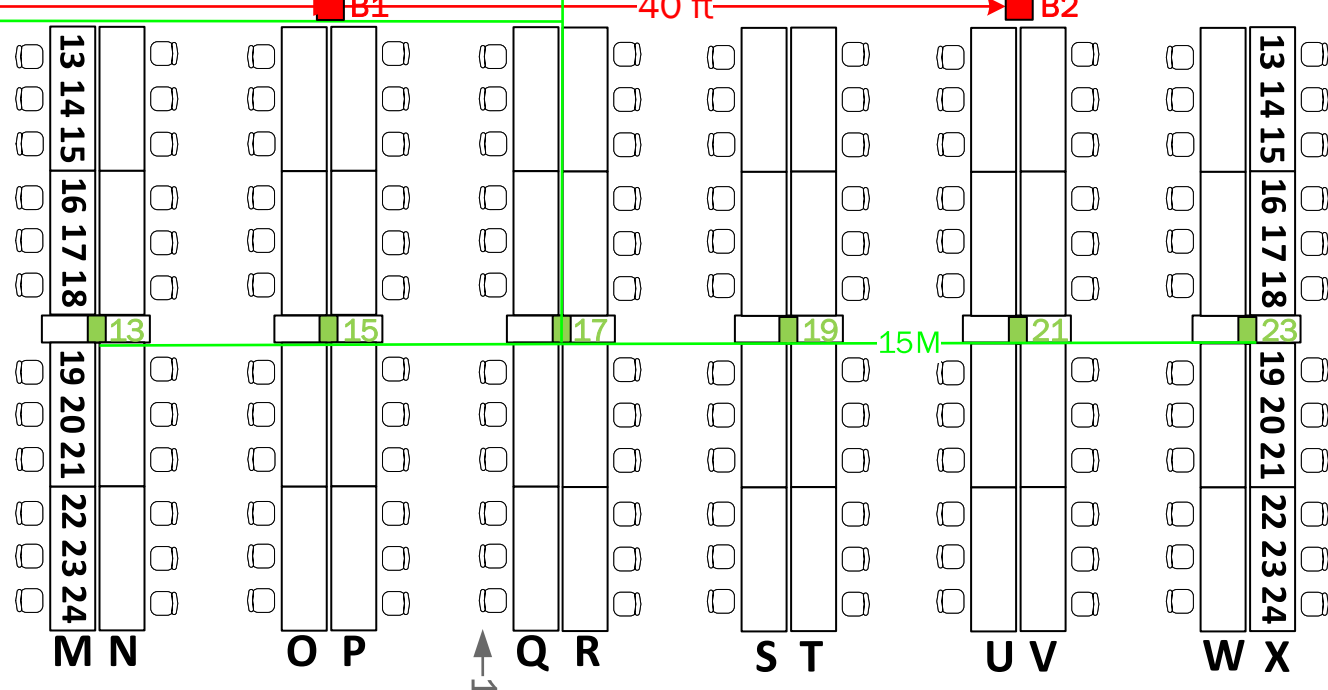
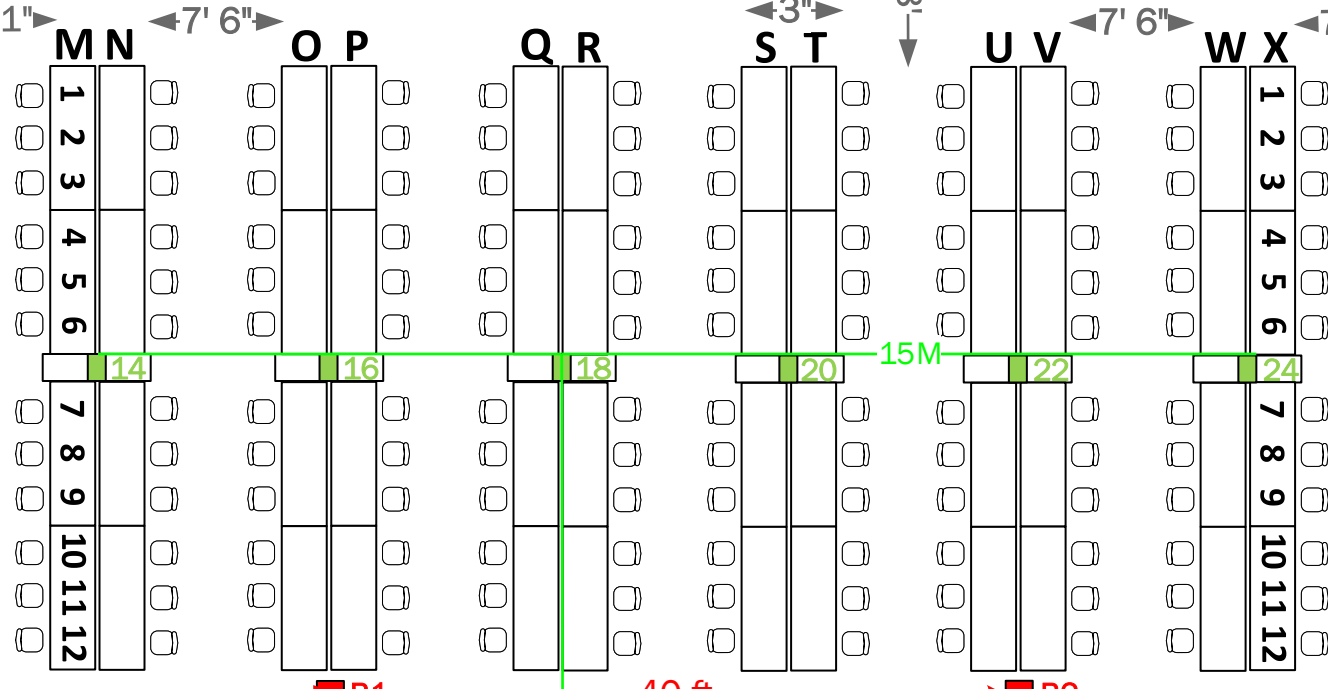

102

118

Entrance

122

Concessions

Concessions

220 Ft

v14